

Tritex II EIP Option & EtherNet/IP AOI

**CURTISS -
WRIGHT**

Installation & Service Instructions

Rev. A | 10/18/22

EXLAR®

EtherNet/IP™

(TTX, T2X, TDX, R2M/G, RDM/G)

TRITEX® SERIES



This document does not contain any export-controlled technical data.

Information furnished by Exlar Corporation is believed to be accurate and reliable. However, no responsibility is assumed by Exlar Corporation for its use. Exlar reserves the right to change the design and operation of the equipment described herein and any associated motion products that may appear in this document. Information in this document pertaining to equipment not furnished by Exlar should be confirmed by that equipment manufacturer. Exlar assumes no responsibility for changes to information by other manufacturers or errors in that information or the description of that information. Information in this document is subject to change without notice.

CONTENTS

1. WHAT IS ETHERNET/IP	4
2. EXPERT SOFTWARE	4
2.1 Scaling	4
2.2 Network – EtherNet/IP	7
2.2.1 IP Parameters and Status	7
2.2.1.1 Current TCP/IP Properties.....	8
2.2.1.2 Status	8
2.2.1.3 Edit TCP/IP Properties	9
2.2.2 Mapping I/O Registers	9
2.2.2.1 How to configure	9
2.2.2.2 How to Monitor IO	10
2.2.2.3 Rockwell EDS File.....	11
3. EIP-AOI OBJECT MODULE	11
3.1 PLC Inputs	11
3.2 PLC Outputs.....	12
4. CONFIGURE PLC	13
4.1 Implicit Configuration	13
4.2 Explicit Configuration Example	16
4.2.1 Explicit Example Get Attribute Single	16
4.2.2 Explicit Example Set Attribute Single	19
5.0 AOI	21
5.1 AOI Data Types	21
5.1.1 Exlar_Drive	21
5.1.1.1 Exlar_Control - Outputs	21
5.1.1.2 Exlar_Status - Inputs.....	22
5.2 Drive (T2Drive)	23
5.3 User Units (T2UU)	24
5.4 Control (T2CON)	24
5.5 Status (T2STA)	26
5.6 JOG (T2JOG)	28
5.7 Move (T2MOV)	29
5.8 Host Control (T2HC)	32
6. USING THE AOI	33
6.1 Importing AOI	33
6.2 Examples	35
6.2.1 Host Control	36
6.2.2 Jog	39
7. TROUBLESHOOTING	40
8. GLOSSARY OF TERMS	41

Advisory

The Tritex II (TTX, T2X, TDX, R2M/G, RDM/G) actuator with EtherNet/IP (EIP option) is only one component of a system that must be carefully engineered to provide safe and reliable operation. Normal and anticipated abnormal operating conditions must be considered, including start-up sequencing, normal loading and operation, abnormal operating conditions such as jams, failure modes of each component in the system, and shutdown.

General Specification

	EtherNet/IP specification
Exlar Vendor ID	1186
Device Type	Generic
EDS	Yes
Rockwell AOI available	Yes
BOOTP	Default: Disable
Static IP	Default: 192.168.0.254
RPI	Recommend > 20
Messaging Type	Implicit or Explicit
I/O	Assembly 101 is defined for Host Inputs (Tritex Outputs) with a data size of 101 16-bit registers. Assembly 102 is defined for Host Outputs (Tritex Inputs) with a data size of 101 16-bit registers. Assembly 128 is defined for Configuration with a data size of 0 registers.

1. WHAT IS ETHERNET/IP

EtherNet/IP™ is a best-in-class Ethernet communication network that provides users with the tools to deploy standard Ethernet technology (IEEE 802.3 combined with the TCP/IP Suite) in industrial automation applications while enabling Internet and enterprise connectivity...data anytime, anywhere. The Industrial Internet of Things (IIoT) and Industry 4.0 are providing manufacturers with significant opportunity for innovation. To capitalize on this opportunity and be able to connect all devices – not just those connected to controllers – industrial users must invest in networks that support the Internet Protocol. Through its reliance on standard Internet and Ethernet standards, EtherNet/IP is proven, complete and ready for Industry 4.0 and IIoT both today and tomorrow.

Like all CIP Networks, EtherNet/IP utilizes the Common Industrial Protocol (CIP™) for its upper layers. CIP Networks follow the Open Systems Interconnection (OSI) model, which defines a framework for implementing network protocols in seven layers: physical, data link, network, transport, session, presentation and application. Networks that follow this model define a complete suite of network functionality from the physical implementation through the application or user interface layer.

CIP encompasses a comprehensive suite of messages and services for a variety of manufacturing automation applications, including control, safety, security, energy, synchronization & motion, information and network management. As a truly media-independent protocol that is supported by hundreds of vendors around the world, CIP provides users with a unified communication architecture throughout the manufacturing enterprise.

2. EXPERT SOFTWARE

2.1 SCALING

All Modbus RTU registers contain sixteen bits of data. Data that requires more than sixteen bits uses multiple consecutive registers to store the data value. Integer data requiring more than sixteen bits is stored in Little Endian word order – the least significant data word is stored first (at the lowest register ID). All integer data is stored in two's complement format. Both ends of the data exchange, Tritex and PLC, must scale the values the same way to work. The drive's DSP controller does not directly support floating-point math. For efficiency, the drive uses fixed-point numeric representation for real numbers. A fixed-point number specifies the number of binary bits used to represent the integer part of the value and the number of binary bits used to represent the fractional part of the value. A fixed-point format of 2.14, for example, specifies a 16 bit word that uses two bits to represent the integer part and fourteen bits to represent the fractional part. A normal integer (in the range 0 to 65535) uses all 16 bits to represent the integer part of the value and could be specified as a 16.0 fixed-point number.

Specifying a particular data type for a register is a simple convenience to better describe the format and internal use of the data. All data could be typed only as N-bit (N = 16, 32, 128, etc.) or N-word (N = 1, 2, etc.) describing the number of bits or registers required to store the data. Specifying a data type of UINT16 (instead of just '16') is more descriptive and carries the additional information that the register is a non-negative integer in the range of 0 to 65535. Taking this one step further, describing a register as type UCUR16 instead of the more generic UINT16 specifies that the value should be interpreted as an unsigned 9.7 fixed-point amperage value.

Exlar Tritex II EIP_AOI Manual

User Units |

Linear Actuator
 Rotary Motor / Gear Motor
 Combo (Rotary + Linear Actuator)
 Custom User Defined

Select actuator lead: per revolution

Where to find drive information on actuator label

www.exlar.com Tritex® TTX Series Product of U.S.A.
Mod: TTX080 - aaa - bb - X - c - d - Y - eee - f - g Model Stroke Lead Stator

www.exlar.com Tritex II™ Series Product of U.S.A.
Mod: T2M115 - 0602 - NEM - HD - 238-20 - 230 SIO

	Units	Decimal Places	Display Text	Scale Factor
Distance:	<input type="text" value="Revs"/>	<input type="text" value="0.000"/>	<input type="text" value="REVS"/>	<input type="text" value="1.52587890625E-05"/>
Velocity:	<input type="text" value="RevsPerMinute"/>	<input type="text" value="0.0"/>	<input type="text" value="RPM"/>	<input type="text" value="3.57627868652344E-06"/>
Acceleration:	<input type="text" value="RevsPerMinutePerSecond"/>	<input type="text" value="0"/>	<input type="text" value="RPM/S"/>	<input type="text" value="5.7220458984375E-05"/>

Current:

The important concept is that all parameters that represent a number are scaled to fit into Modbus registers but are displayed in Expert in a way that makes much more sense to the user. The Scale Factor value could be used by the PLC to convert to actuator internal values. Reference T2UU for more information.

System Setup – Comms Faults Tab

The *Comms Faults* tab is used to set up the conditions that will be monitored to determine a host communication exception condition. The *Fault Enables* tab settings control the action taken on occurrence.

Channel A is dedicated as the RS-485 port included on all models. Channel B is used with the Ethernet based advanced communications protocols, between the Exlar EIP interface and processor board. It does not indicate EtherNet/IP protocol error has occur.

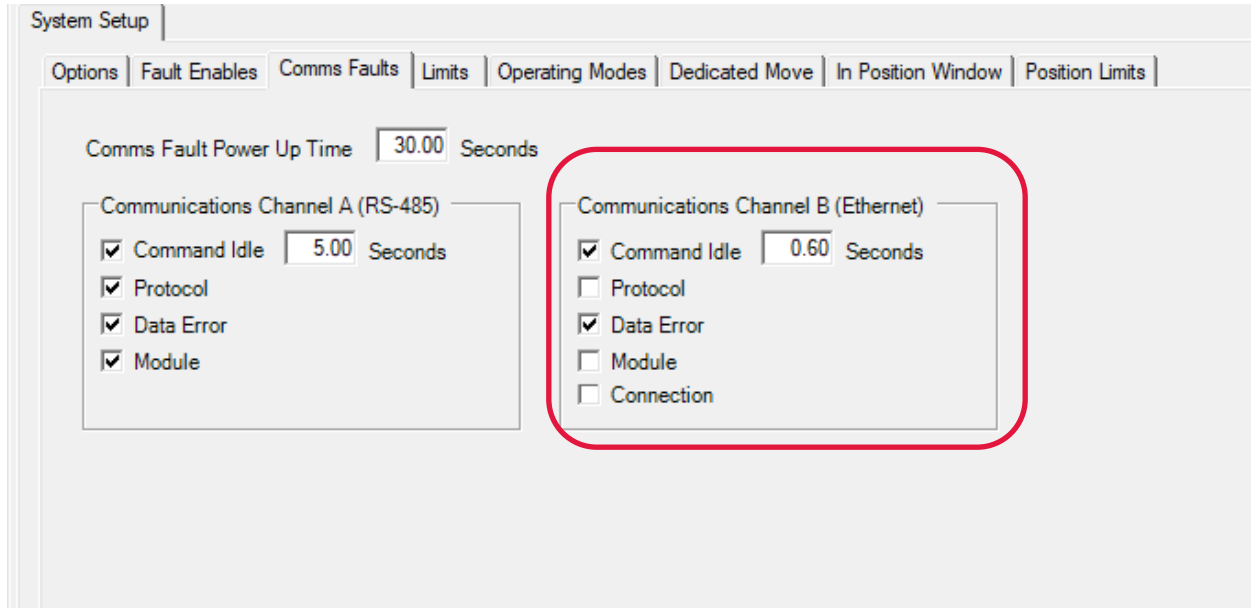

2.2 NETWORK – ETHERNET/IP

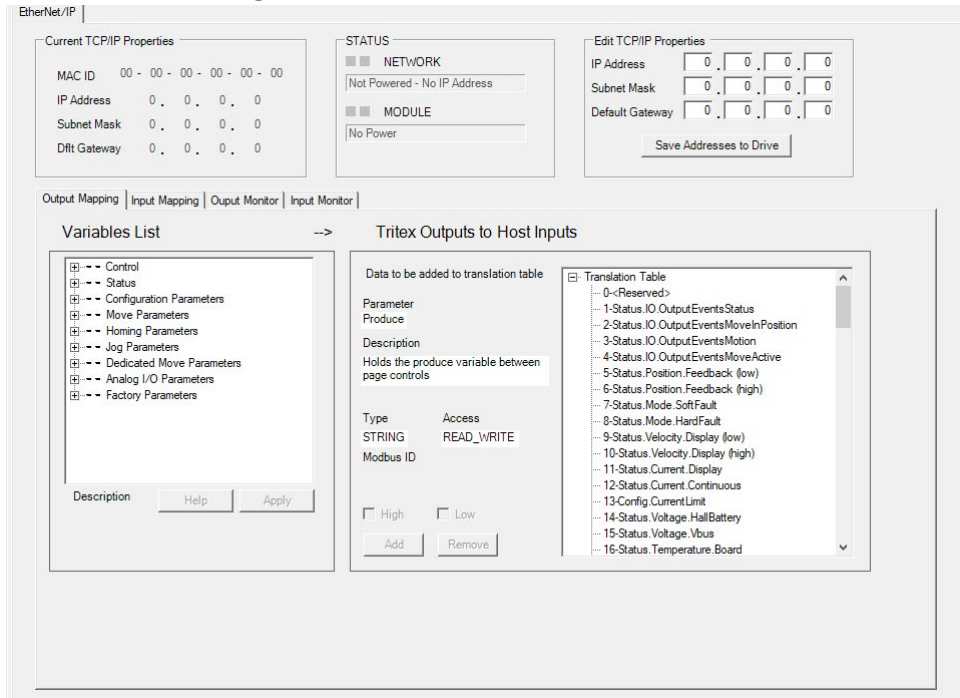

The Tritex II EtherNet/IP (EIP) option board supports the following features:

- Device IP Address assignment through BOOTP or through Tritex Expert software
- Drive commissioning through standard Modbus RTU communication to Tritex Expert software
- EtherNet/IP device capable of Implicit I/O messaging
- Exlar supplied EDS file included in the installation of Expert software
 - o C:\Program Files (x86)\Exlar\Tritex\Comms Files\Ethernet IP
- Up to 100 input registers (INT16) and 100 output registers (INT16) are available to be user mapped to Tritex parameters through the Tritex Expert software
- Full functional control of Tritex parameters

2.2.1 IP Parameters and Status

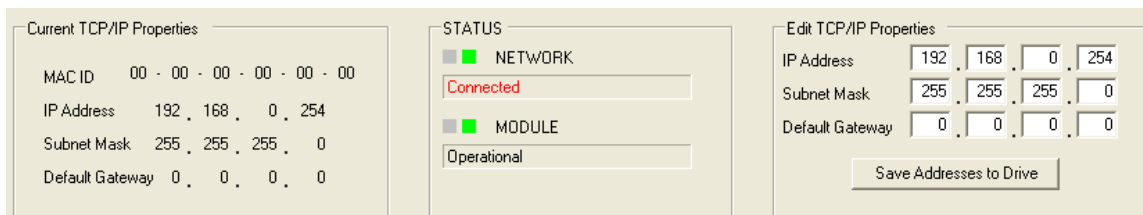

Offline view of the Active IP parameters and Address Setup fields

Using the Tritex Expert software, you will see the above values populate the Active IP parameters. Here the Ethernet MAC-ID, IP Address, Subnet Mask and Default Gateway are display. The data enter fields to the right are used to configure the IP Address, Subnet Mask and Default Gateway when BOOTP is disable.

2.2.1.1 Current TCP/IP Properties

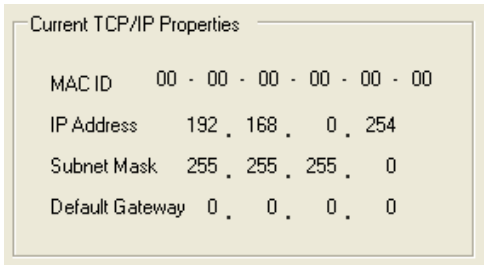

Display Tritex active IP parameters

2.2.1.2 Status

Status indicators, help maintenance personnel to quickly identify the status of the Network connection and interface module.

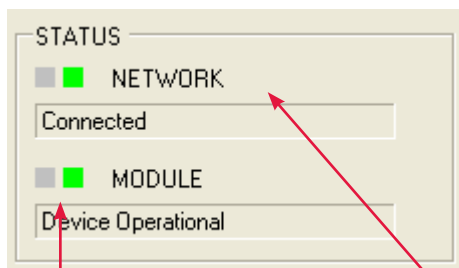

Two types of status indicators are provided:

- Network status indicator
- Module status indicator

Network Status		
Indicator State	State	Description
Steady Off	No Powered / No IP	The device is powered off or is powered on but with no IP address configured
Steady Green	Connected	At least one CIP (Implicit) connection is established
Flashing Green	No, I/O Connection	An IP address is configured, but no CIP connection is established
Flashing Red	Connection timeout	The established CIP connection has timeout
Steady Red	Duplicate IP	Duplicate IP address detection, the interface module has detected that its IP address is already in use.

Module Status		
Indicator State	State	Description
Steady Off	No power	The interface module has no power supplied to it
Steady Green	Operational	The interface module is operating correctly
Flashing Green	Standby	The interface module has not been configured
Flashing Red	Minor fault	Recoverable error is active; the error information will be loaded in the first word of the PLC input status word. Fault will clear on the next valid message
Steady Red	Major Fault	The interface module has detected a non-recoverable major fault.
Flashing Green/ Red	Self-Test	The interface module is performing power-up testing

2.2.1.3 Edit TCP/IP Properties

To set the IP Address, Subnet Mask or Gateway modify the fields to your specific needs and select **Save Addresses to Drive**. These changes will not take effect until the power to the Tritex is cycle. Upon power up the new, IP Address will be assigned and will show up in the Active MAC-ID parameter container.

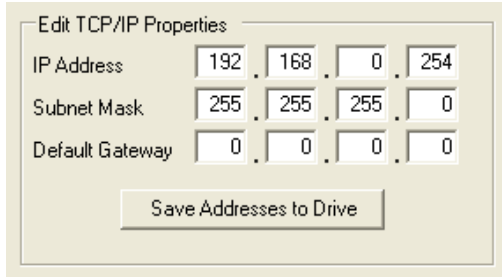

NOTE! BOOTP must be disabled to utilize the IP address setting through the Tritex Expert Software

2.2.2 Mapping I/O Registers

2.2.2.1 How to configure

All Tritex functionality is parameter based. This means there is a listing of parameters associated with every functional capability of the Tritex. When setting up the EtherNet/IP mapping to the 101 Inputs and 101 Outputs, first a list of the parameters must be defined and determined whether they are *Read Parameters* from the EtherNet/IP Host or *Write Parameters* to the EtherNet/IP Host. Once this list is created, mapping the parameters to the *Translation Table* of registers is done as shown in the Figure below. The *Output Mapping* tab is used to map the parameters that are output by the Tritex and read into the *Host*. The *Input Mapping* tab is used to map the parameters that are input to the Tritex and written from the *Host*. The *Input Monitor* and *Output Monitor* tabs work in the same manner.

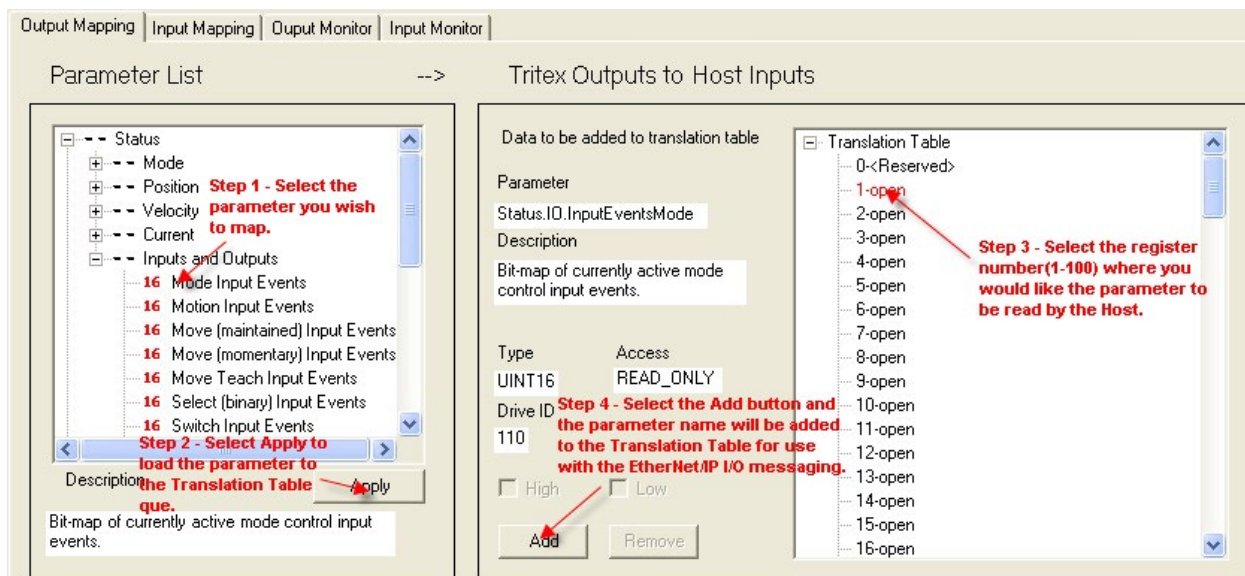

Selecting parameters to be mapped to the Translation Table.

After *Step #2* in the Figure above, the information about the parameter is displayed. 32 bit or double word parameters can only be assigned to tables starting with odd numbers. If a 32-bit parameter is selected and even table number is selected the *Add* button will be gray. If, for example, only half of a 32 bit parameter is needed (all velocities are 32 bit parameters) their data format is 8.24 revs/sec and rarely would 24 bits of precision be needed to the right of the decimal point), the user could select only the *High* word of the parameter, by un-checking the *Low* box, resulting in a 16 bit velocity parameter in the format of 8.8 revs/sec , 8 bits on each side of the decimal point.

Assigning the parameters to be transferred between the Tritex and PLC is simple; the hard part is understanding the Tritex parameters and their format so they can be controlled from the PLC. The *Tritex II Parameters Manual* describes the function of every parameter, in some cases even the interaction with other parameters, and most importantly the format of data for each parameter. Parameters such as *Move* distances and *Velocity* are straight forward, however, many of the parameters used for control are 16-bit registers represented by bit maps or Enumeration tables; the common bit maps are covered in *Appendix A* of the *Tritex II Parameters Manual*.

2.2.2.2 How to Monitor IO

To assist with validating the data sent/received, the *Input/Output Monitor* tabs allow the user to view the non-scaled decimal value of the 16-bit register. This value will match the value observed from the *Host*. See Figure below to identify its use.

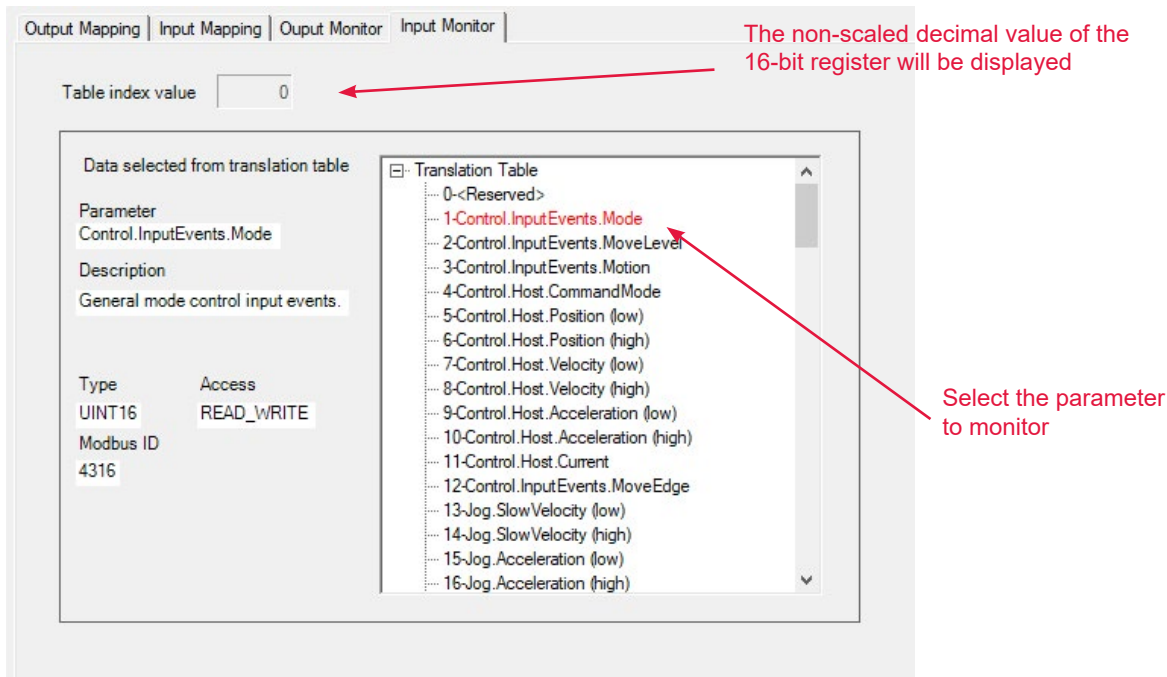

Monitoring parameters to validate data sent/received by the host.

2.2.2.3 Rockwell EDS File

The installation of the Tritex Expert Commissioning software includes the Rodwell EDS file.

- C:\Program Files (x86)\Exlar\Tritex\Comms Files\Ethernet IP

3. EIP-AOI OBJECT MODULE

The Tritex has a set of 101 input and 101 output 16-bit registers that are transfer with each update. These registers are map to specific parameter definition in the Tritex Expert Software. The first item in both Input and output block contains unmappable register, which is defined in this section.

- Assembly 101 is defined for Host Inputs (Tritex Outputs) with a data size of 101 16-bit registers.
- Assembly 102 is defined for Host Outputs (Tritex Inputs) with a data size of 101 16-bit registers.
- Assembly 128 is defined for Configuration with a data size of 0 registers.

3.1 PLC INPUTS

The first word of the PLC input provides the status of the Tritex communication. It provides information concerning the status of the connection, health of the Tritex option board. Typically, this word contains zero unless there is an active error.

Bit (0 = LSB)	Input Status Word
0	Error – Tritex is responding with error codes. Extended Module Status (Attribute 101) contains additional error information.
1	Error – communication with Tritex timed-out (was previously established)
2	Error – communication with Tritex cannot be established at all
3-7	Reserved
8	Unit is currently active at factory defaults
9	Unit has a new configuration that will take effect upon reset.
10-15	Reserved

Instance 101 Word	PLC Inputs	
	Modbus ID	Description
0	<Reserved>	Input Status Word
1	104	Status.IO.OutputEventsStatus
2	108	Status. IO.OutputEventsMoveInPosition
3	105	Status.IO.OutputEventsMotion
4	107	Status.IO.OutputEventsMoveActive
5	378	Status Position Feedback (low)
6	-	Status Position Feedback (High)
7	7	Status.Mode,SoftFaults (Warnings)

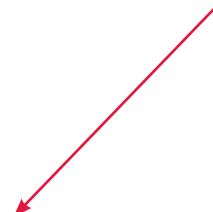

8	6	Status.Mode.HardFault (Faults)
9	356	Status Velocity Display (Low)
10	-	Status Velocity Display (High)
11	567	Status Current Display
12	565	Status Current Continuous
13	5108	Config.CurrentLimit
14	8	Status.Voltage.HallBattery
15	571	Status.Voltage.Vbus
16	11	Status.Temperature.Board
17	15	Status.Temperature.Actuator
18-100		

3.2 PLC OUTPUTS

The first word is defined as the Run/Idle command for the Tritex II Outputs. When an I/O connection is active, a zero (0) in this bit represents Idle Mode and a one (1) represents Run Mode. In Idle mode, the Tritex will only update PLC Inputs (Tritex Output) information.

Name	Description
Run/Idle	0: Idle - Tritex Output List are not updated 1: Run - Tritex Output List are updated

Instance 102 Word	PLC Outputs	
	Modbus ID	Description
0	<Reserved>	Run/Idle
1	4316	Control.InputEvents.Mode
2	4318	Control.InputEvents.ModeLevel
3	4317	Control.InputEvents.Motion
4	4303	Control.Host.CommandMode
5	4304	Control.Host.Postion(low)
6		Control.Host.Postion(High)
7	4306	Control.Host.Velocity(Low)
8		Control.Host.Velocity(High)
9	4308	Control.Host.Acceleration(Low)
10		Control.Host.Acceleration(High)
11	4310	Control.Host.Current
12	4319	Control.InputEvents.moveEdge
13	6022	Jog Slow (low)
14		Jog Slow (High)
15	6026	Jog Acceleration (Low)
16		Jog Acceleration (High)

17	6100	Move 0 – Options
18	6101	Move 0 – Current Limits
19	6102	Move 0 – Acceleration (Low)
20		Move 0 – Acceleration (High)
21	6500	Move 0 – Deceleration (Low)
22		Move 0 – Deceleration (High)
23	6106	Move 0 – Primary - Options
24		<open>
25	6108	Move 0 – Primary – Position (Low)
26		Move 0 – Primary – Position (High)
27	6110	Move 0 – Primary – Velocity (Low)
28		Move 0 – Primary – Velocity (High)
29	6112	Move 0 – Secondary - Options
30		<open>
31	6114	Move 0 – Secondary – Position (Low)
32		Move 0 – Secondary – Position (High)
33	6116	Move 0 – Secondary – Velocity (Low)
34		Move 0 – Secondary – Velocity (High)
35 -100		

4. CONFIGURE PLC

4.1 IMPLICIT CONFIGURATION

The following example describes the process used to configuring I/O system with RSLogix 5000™ and Tritex with EtherNet/IP.

1. Run RSLogix 5000™ software and configure the PLC for the correct processor, rack and slot configurations.
2. Right click on the Ethernet folder located under I/O Configuration and left click to add a new module to this folder.

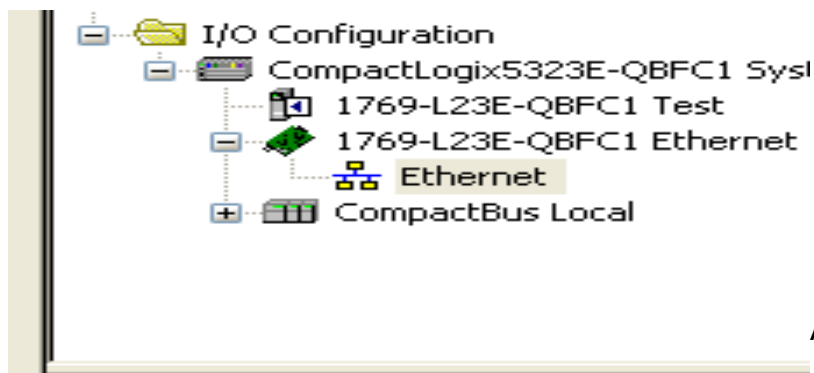

Adding a New module using PLCs Software

3. Choose the Allen-Bradley –Generic Ethernet-Module. After selecting a name for the device, click **OK**.

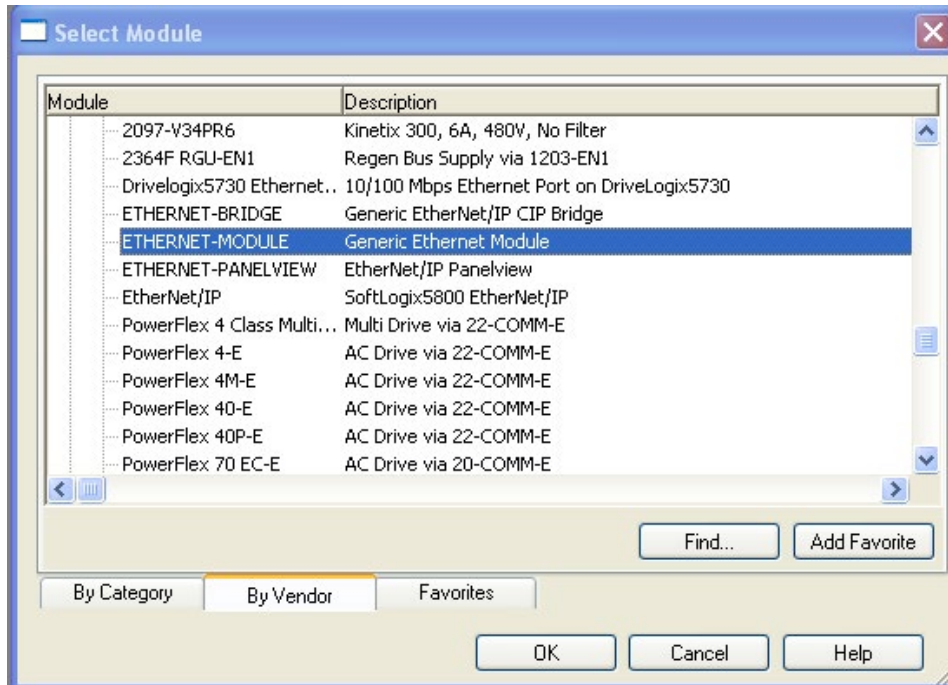

Choose EtherNet/IP Module type

4. Configure **New Module** Connection Properties, IP Address and Comm Format. Assign name to new Module (Tritex) and then select OK.

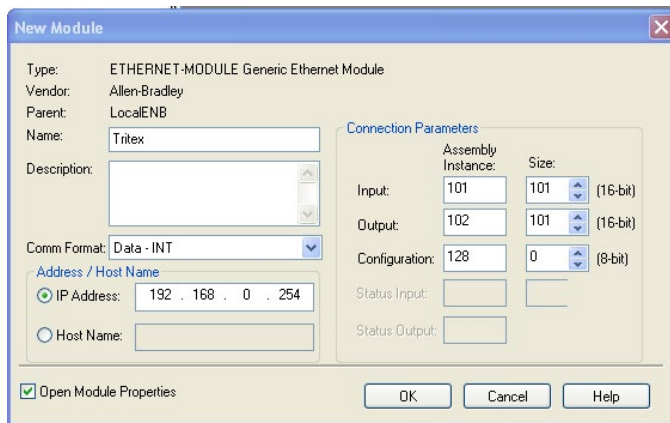

Specify address and Connection Parameters

5. Connection

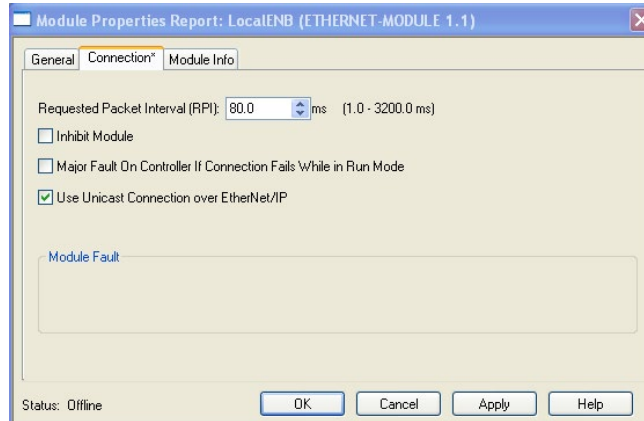

Configuring New Module Connection

- **Request Packet Interval (RPI):** This field specifies the Requested Packet Interval (RPI), which defines the amount of time (in milliseconds) between the data exchanges across an implicit messaging connection.

NOTE!

RPI > 20 Recommended

- **Inhibit Module:** Checking this box prevents the PLC from attempting to establish a connection with the Tritex. Refer to RSLogix for additional information on this function.
- **Major Fault on Controller If Connection Fails While in Run Mode:** This option will cause the controller to generate a major fault when the connection fails.
- **Use Unicast Connection over EtherNet/IP:** Select Unicast or Multicast for EtherNet/IP connection base on system needs.

NOTE!

Unicast vs. Multicast
Unicast packets are sent directly to a single device. Multicast packets are sent to all devices on the network by default.

6. Verify configuration

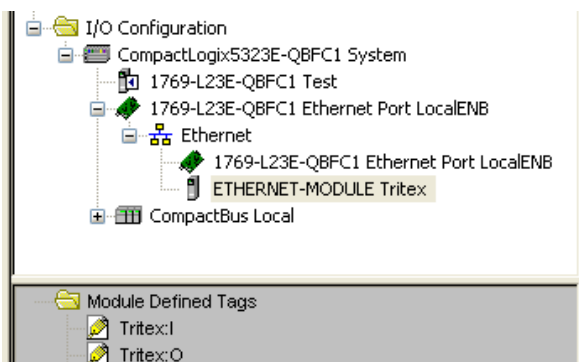

Example Project tree – Added Tritex

By highlight the “Controller tags” in the project tree, it is possible to view the newly added Tritex. See Image below.

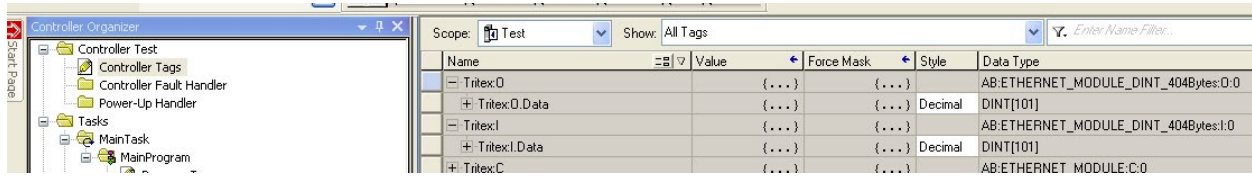

Example Controller tags for Tritex

NOTE!

For the above example. To update Tritex Outputs – TritexO.Data[0].0 must be turn ON.

4.2 EXPLICIT CONFIGURATION EXAMPLE

Explicit Messaging is used to transfer data that does not require continuous updates. With explicit messaging, you can configure and monitor Tritex parameters on the EtherNet/IP network.

The RSLogix™ software can be configured to send an EtherNet/IP message to the Tritex by using the Message (MSG) Instruction.

- Get Attribute Single (Read)
- Set Attribute Single (Write)

4.2.1 Explicit Example Get Attribute Single

The following ladder diagram demonstrates the ladder instructions needed to send explicit message from CompactLogix L23E Ethernet to the Tritex Inputs.

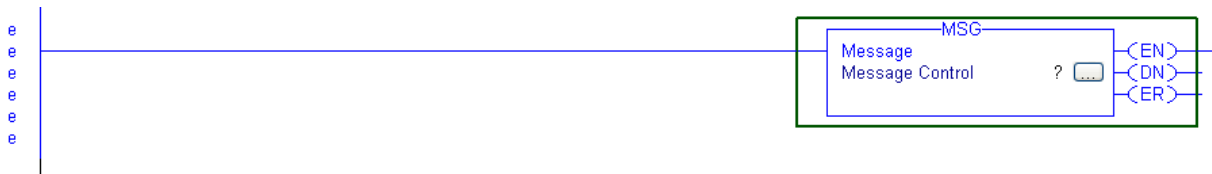

Ladder Diagram Get

1. Add Message Instruction to RSLogix5000™ ladder Diagram.

NOTE!

To display the Message Configuration dialog box in RSLogix5000, add a message instruction (MSG), create a new tag for the message (properties: Base tag type, MESSAGE data type, controller scope), and click the blue box inside the message.

2. Create new tag for the MSG (Message) Instruction.

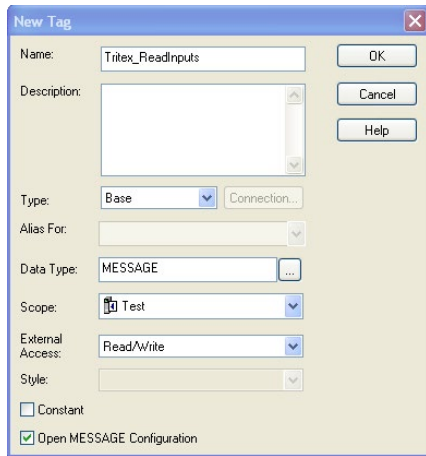

Get Message New Tag

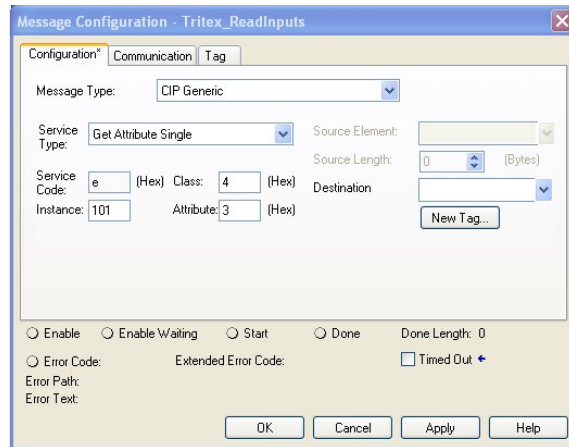

Get Message Configuration Properties

3. In new Tag menu, assign name to tag, Check **Open MESSAGE Configuration** box, then click **OK**.

4. Configure Message Configuration parameters.

Configuration	Value	Description
Message Type	CIP Generic	Message Format
Service Type	Get Attribute Single	Read parameter data
Service Code	e (Hex)	Get_Attribute_Single
Class	4 (Hex)	Assembly Object
Instance	101 (Dec)	Assembly Input Object Instance
Attribute	3 (Hex)	Parameter Value
Destination	Tritex_InputData	Controller Tag for response data

Tritex_ReadInputs

5. In the Message Configuration section for Message click on the **Communications Tab**, this tab will allow the setting of the target device to get the explicit message.

- 5.1 Click and open Message Path **Browser** and select local Ethernet module in PLC.
- 5.2 Configure Path

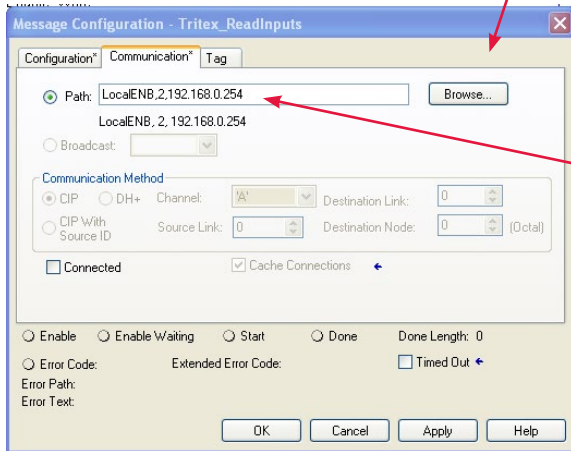

Description	
LocalENB	Local communication module
2	EtherNet/IP port #
192.168.0.254	Tritex address

Get Communication Properties

- **Path** - shows the route that the message takes to get to the destination. It is a combination of the Ethernet Card, location in the PLC and the module address. Refer to your PLC user manual for more information on configuring Path.
- **Timed Out** option – Time out for an unconnected message or for making a connection.

6. After configuring Path, Return to **Configuration** Tab.

7. From Configuration Parameters Menu, click **New Tag** and define *Destination Tag* for Input data.

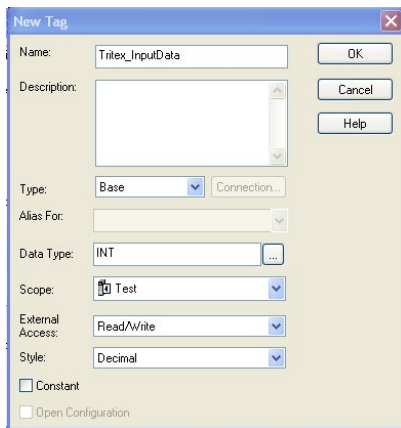

Destination Tag

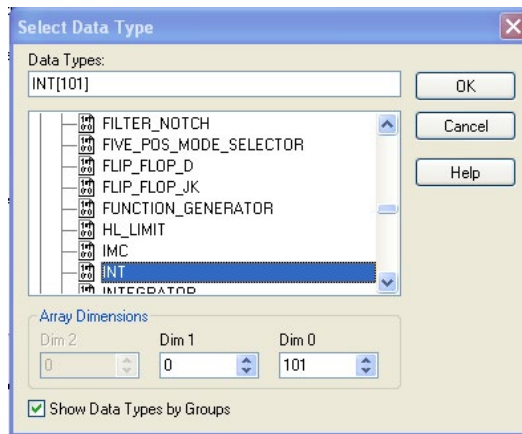

Destination size

- From Tag Menu select icon next to Data Type and change **INT Dim 0** to “101”, then click **OK**, returning to New Tag Menu. Click **OK** to Defined New Destination Tag “Tritex_InputData”.

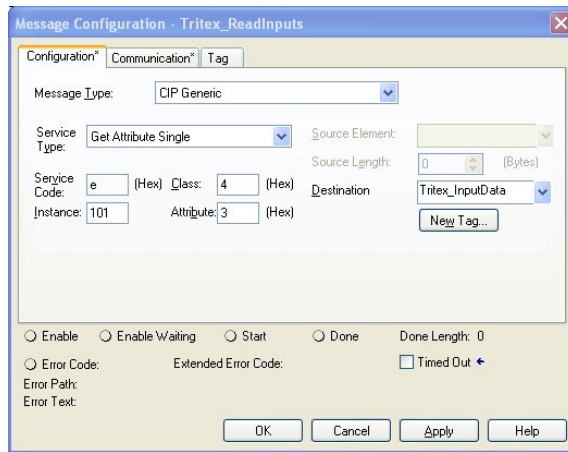

Get Message Configuration Properties

- From the Message Configuration Menu select Destination Tag name “Tritex_InputData”. Click **Apply** button to configure Message Instruction

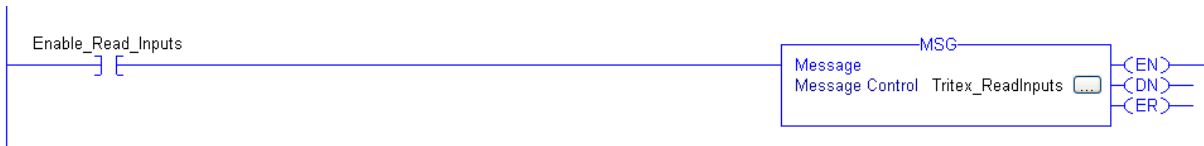

MSG Read Tritex Inputs

NOTE!

Refer to Allen-Bradley Logix5000 Controllers General Instruction Manual for additional information on Message (MSG) Instruction and Application Configuration Details.

XIC instruction is used to trigger Explicit MessageA read

4.2.2 Explicit Example Set Attribute Single

The following ladder diagram demonstrates the ladder instructions needed to send explicit message from CompactLogix™ L23E Ethernet to the Tritex Outputs.

- Add Message Instruction to RSLogix5000™ ladder Diagram. Please see figure 23.
- Create new tag for the MSG (Message) Instruction.
- In new Tag menu, assign name to tag, Check Open MESSAGE Configuration box, then click OK.
- Configure Message Configuration parameters. See below.

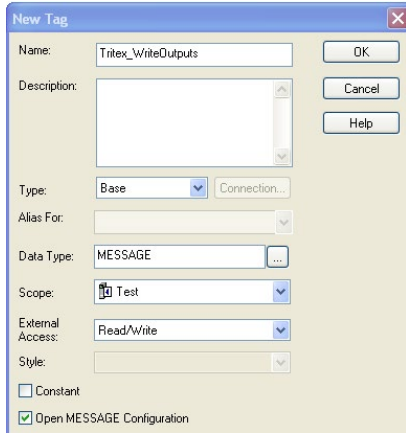

Set – Message Tag

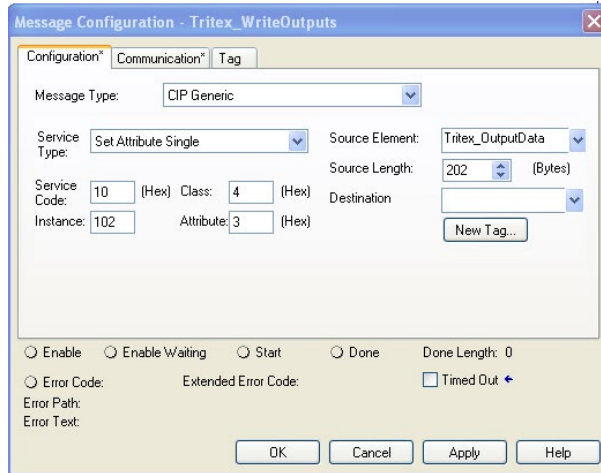

Set Message Configuration Properties

Configuration	Value	Description
Message Type	CIP Generic	Message Format
Service Type	Set Attribute Single	Write parameter data
Service Code	10 (Hex)	Set_Attribute_Single
Class	4 (Hex)	Assembly Object
Instance	102 (Dec)	Assembly Output Object Instance
Attribute	3 (Hex)	Parameter Value
Source Element	Tritex_OutputData	Controller Tag for response data
Source Length	202 Bytes	101 16-bit words of data is sent to Tritex

Tritex_WriteOutputs

- In the Message Configuration section for Message click on the **Communications Tab**, this tab will allow the setting of the target device to get the explicit message.
- After configuring Path, Return to **Configuration Tab**.
- From Configuration Parameters Menu, click **New Tag** and define Source Tag for Output data.

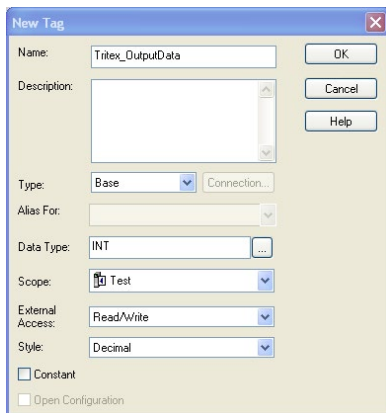

Set Source Element Tag

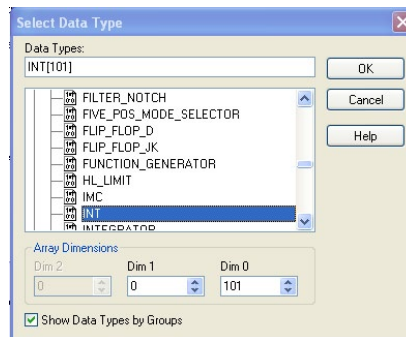

Set Source Element size

- From Tag Menu select icon next to Data Type and change **INT** Dim 0 to "101", then click **OK**, returning to New Tag Menu. Click **OK** to Defined New Source Element Tag "Tritex_OutputData"

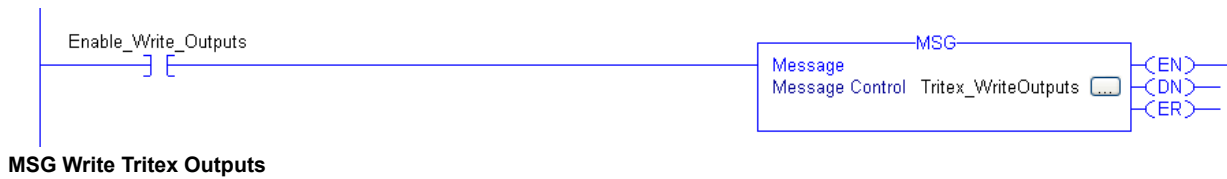

NOTE!

Refer to Allen-Bradley Logix5000 Controllers General Instruction Manual for additional information on Message (MSG) Instruction and Application Configuration Details.

XIC instruction is used to trigger Explicit Message write

5.0 AOI

5.1 AOI DATA TYPES

The AOI uses the struct class to create a custom data type. The AOI library itself is a collection of custom types that you can use in your own applications

<div style="border: 1px solid black; padding: 5px; margin-bottom: 5px;">Exlar_Drive</div> <div style="margin-left: 20px;">Exlar_Control</div> <div style="margin-left: 20px;">Exlar_Status</div>	<p>Data type</p> <p>Exlar _Drive contains:</p> <p>Data types of Exlar Control and Exlar Status</p>
--	--

5.1.1 Exlar_Drive

Tag	Data Type	Description
Control	Exlar_Control	Outputs
Status	Exlar_Status	Inputs

5.1.1.1 Exlar_Control - Outputs

Tag	Data Type	Drive Translation Table - Inputs	Modbus ID
EnableOutputs	INT	Enable Outputs	- - - -
InputEventsMode	INT	Control.InputEvents.Mode	4316
InputEventsModeLevel	INT	Control.InputEvents.MoveLevel	4318
InputEventsMotion	INT	Control.InputEvents.Motion	4317
HostCommandControlMode	INT	Control.Host.CommandMode	4303
HostPosition_low	INT	Control.Host.Position.low	4304
HostPosition_high	INT	Control.Host.Position.high	-

HostVelocity_low	INT	Control.Host.Velocity.low	4306
HostVelocity_high	INT	Control.Host.Velocity.high	-
HostAcceleration_low	INT	Control.Host.Acceleration.low	4308
HostAcceleration_high	INT	Control.Host.Acceleration.high	-
HostCurrent	INT	Control.Host.Current	4310
InputEventsMoveEdge	INT	Control.InputEvents.MoveEdge	4319
JogSlowVelocity_low	INT	Jog.SlowVelocity.low	6022
JogSlowVelocity_high	INT	Jog.SlowVelocity.high	-
JogAcceleration_low	INT	Jog.Acceleration.low	6026
JogAcceleration_high	INT	Jog.Acceleration.high	-
MoveOption	INT	Move.0.Options	6100
MoveCurrentLimit	INT	Move.0.CurrentLimits	6101
MoveAcceleration_low	INT	Move.0.Acceleration.low	6102
MoveAcceleration_high	INT	Move.0.Acceleration.high	-
MoveDeceleration_low	INT	Move.0.Deceleration.low	6500
MoveDeceleration_high	INT	Move.0.Deceleration.high	-
MovePrimaryOption	INT	Move.0.Primary.Options	6106
spare	INT	Open	----
MovePrimaryPosition_low	INT	Move.0.Primary.Position.low	6108
MovePrimaryPosition_high	INT	Move.0.Primary.Position.high	-
MovePrimaryVelocity_low	INT	Move.0.Primary.Velocity.low	6110
MovePrimaryVelocity_high	INT	Move.0.Primary.Velocity.high	
MoveSecondaryOption_low	INT	Move.0.Secondary.Options	6112
Spare2	INT	Open	----
MoveSecondaryPosition_low	INT	Move.0.Secondary.Position.low	6114
MoveSecondaryPosition_high	INT	Move.0.Secondary.Position.high	-
MoveSecondaryVelocity_low	INT	Move.0.Secondary.Velocity.low	6116
MoveSecondaryVelocity_high	INT	Move.0.Secondary.Velocity.high	-

5.1.1.2 Exlar_Status - Inputs

Tag	Data Type	Drive Translation Table - Inputs	Modbus ID
EIP_Comm	INT	EIP module communication status	4203
OutputEventsStatus	INT	Status.IO.OutputEvents.Status	104
OutputEventsMoveInPosition	INT	Status.IO.OutputEventsMoveInPosition	108
OutputEventsMotion	INT	Status.IO. OutputEventsMotion	105
OutputsEventsMotionActive	INT	Status.IO. OutputsEventsMotionActive	107
PositionFeedback_low	INT	Status.IO.PositionFeedback.low	378
PositionFeedback_high	INT	Status.IO.PositionFeedback.high	-
SoftFaults	INT	Status.IO.SoftFault	7
HardFaults	INT	Status.IO.HardFault	6
VelocityDisplay_low	INT	Status.Velocity.Display.low	356
VelocityDisplay_high	INT	Status.Velocity.Display.high	-

CurrentDisplay	INT	Status.Current.Display	567
CurrentContinuous	INT	Status.Current.Continuous	565
CurrentLimit	INT	Config.CurnnetLimit	5108
VoltageHallBattery	INT	Status.Voltage.HallBattery	8
VoltageBus	INT	Status.Voltage.vBus	571
TemperatureBoard	INT	Status.Temperature.Board	11
TemperatureActuator	INT	Status.Temperature.Actulator	15

5.2 DRIVE (T2DRIVE)

The instruction performs separate Synchronous Copy (CPS) instructions to copy AOI data to/from Tritex II being commanded. While enabling Exlar Tritex II output control bit.

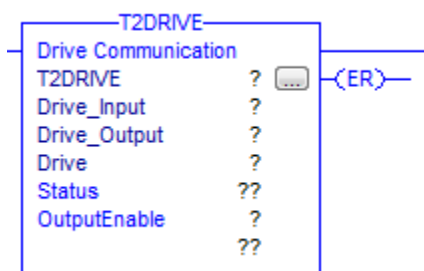

Required	Parameter	Type	Usage	Format	Description
X	Drive_Input	AB:ETHERNET_MODULE_INT_202Bytes:I:0	Input	Tag	Point to Tritex II -- Inputs
X	Drive_Output	AB:ETHERNET_MODULE_INT_202Bytes:O:0	Output	Tag	Point to Tritex II -- Outputs
X	Drive	Exlar_Drive	Output	Tag	Data used by AOI
X	DriveEnable	Boolean	Output	Tag	Enable Tritex II EIP Outputs
	ER	Boolean	Output	Tag	1: if comm fault is active
	Status	DINT	Output	Tag	Communication Status

5.3 USER UNITS (T2UU)

The instruction establishes the values used to convert user units into drive units. It supplies the essential values needed to perform conversion. The Unit parameter output must be linked to all Exlar AOI that contain Unit parameter input.

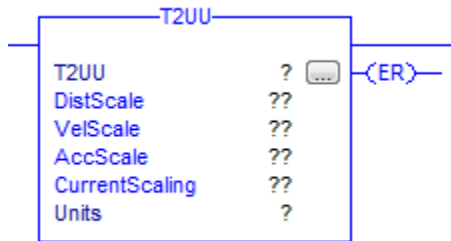

Required	Parameter	Type	Usage	Format	Description	Modbus Alias
X	DistScale	REAL	Input	Tag	Distance User Units Per Rev	---
X	VelScale	REAL	Input	Tag	Velocity Scale	---
X	AccScale	REAL	Input	Tag	Acceleration Scale	---
X	CurrentScale	INT	Input	Tag	Current Scaling 0 =AMPS 1 = % of Config.CurrentLimit – Modbus ID 5108	---
X	Units	Real[5]	Output	Tag	Point to Conversion Unit	---
	ER	BOOL	Output		Instruction error is Active 1: scaling is equal to zero	---

5.4 CONTROL (T2CON)

Use the instruction send commands to drive.

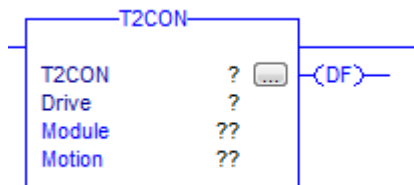

Exlar Tritex II EIP_AOI Manual

Required	Parameter	Type	Usage	Format	Description	Modbus Alias
X	Drive	Exlar_Drive	InOut	Tag	Point to	---
	Module	INT	Input	Immediate or Tag	Module Commands	---
					Bit.0: Enable Momentary The drive will try to enable on the rising edge.	4316.00
					Bit.1: Enable Maintained The drive will be enabled if bus power is applied and there are no active faults	4316.01
					Bit.2: Define Home	4316.10
					Bit.3: Brake Override Force actuator brake relay to be activated, releasing the brake. This input is honored whether or not the drive is enabled and overrides the normal brake behavior	4316.14
					Bit.4: Fault Reset The rising edge will clear any faults active	4316.15
					Motion	INT
	Bit.0: Stop Motion Forces the drive to decelerate using STOP deceleration and hold position. The drive will be forced into a position mode of operation if necessary	4317.02				
	Bit.1: Pause Move If any move is executing, the PAUSE input event will force the drive to decelerate to zero command velocity using the current motion's deceleration and hold position until PAUSE is removed. If no move is active, the PAUSE input event has no effect	4317.03				
	Bit.2: Initiate Home Move The rising edge of the HOME input event initiates the Home Move	4317.08				
	Bit.3: Emergency Move (Dedicated Move)	4317.10				
	DF	BOOL	Output		One or more Drive Fault are active	104.03

5.5 STATUS (T2STA)

Use the instruction to retrieve drive status.

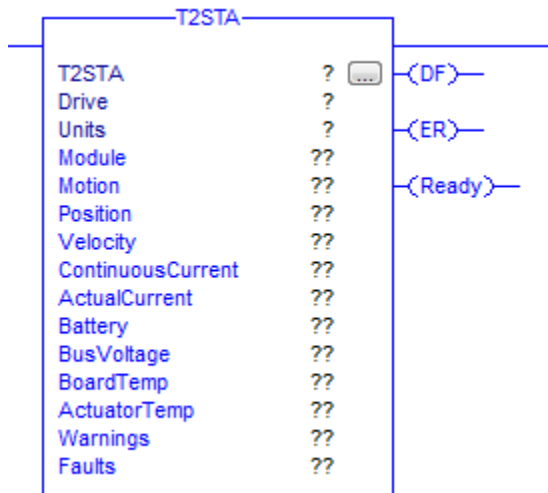

Required	Parameter	Type	Usage	Format	Description	Modbus Alias
X	Drive	Exlar_Drive	InOut	Tag	Point to	---
X	Units	Real[5]	InOut	Tag	Point to T2UU AOI	---
	DF	BOOLEAN	Output		1: A Drive Fault is active	104.03
	Ready	BOOLEAN	Output		1: The <i>READY</i> flag is set when both the <i>ENA</i> and <i>HOMED</i> flags are active indicating that the drive is homed and enabled.	104.02
	ER	BOOLEAN	Output		An Instruction error is Active 1: T2UU error is active	---
	Module	INT	Output	Immediate or Tag	Module Status Bit.0: Enable Bit.1: Homed Bit.2: Ready The <i>READY</i> flag is set when both the <i>ENA</i> and <i>HOMED</i> flags are active indicating that the drive is homed and enabled. Bit.3: Fault Bit.4: Warning Bit.5: Fault or Warning	--- 104.00 104.01 104.02 104.03 104.04 104.05

Exlar Tritex II EIP_AOI Manual

	Motion	INT	Output	Immediate or Tag	Motion Status Bit.0: Stopped Active Bit.1: Paused Active Bit.2: Jogged active Bit.3: Jog Positive Active Bit.4: Jog Negative Active Bit.5: Initiate Home Move Active Bit.6: EMOVE (Emergency Move) Dedicated Move Active Bit.7: Move active Bit.8: In Position active	--- 105.00 105.01 105.02 105.03 105.04 105.05 105.08 105.09 105.12
--	--------	-----	--------	------------------	---	---

Required	Parameter	Type	Usage	Format	Description	Modbus Alias
	Position	REAL	Output	Immediate or Tag	User Units – Position	378
	Velocity	DINT	Output	Immediate or Tag	User Units - Velocity	356
	Continuous Current	REAL	Output	Immediate or Tag	User Units - Continuous Current (Units is based on T2UU CurrentScale configuration)	565
	ActualCurrent	REAL	Output	Immediate or Tag	User Units - Actual Current (Units is based on T2UU CurrentScale configuration)	567
	Battery	INT	Output	Immediate or Tag	Hall Battery Voltage	8
	BusVoltage	INT	Output	Immediate or Tag	Bus Voltage (filter)	571
	BoardTemp	INT	Output	Immediate or Tag	Board Temperature °C	11
	Actuator-Temp	INT	Output	Immediate or Tag	Actuator Temperature °C	15

	Warning	INT	Output	Immediate or Tag	Drive Warnings Bit.0: IPK – Peak Current Bit.1: C – Continuous Current Bit.2: POS – Position Tracking Bit.3: MV – Move Termination Bit.4: VLOW – Low DC Bus Voltage Bit.5: VHIGH – High DC Bus Voltage Bit.6: FE – Positional Following Error Bit.7: BT – Board Temperature Bit.8: AT – Actuator Temperature Bit.9: LOS – Loss of Signal Bit.10: COM – Communications Bit.11: IH – Hardware Over current Bit.12: HB – Absolute Hall Board Battery Bit.13: UP – User Parameters Bit.14: FP – Factory Parameters Bit.15: RS – Restart	7 7.00 7.01 7.02 7.03 7.04 7.05 7.06 7.07 7.08 7.09 7.10 7.11 7.12 7.13 7.14 7.15
	Faults	INT	Output	Immediate or Tag	Drive Faults (<i>Reference Warning for bits</i>)	6

5.6 JOG (T2JOG)

Use the instruction to move an a drive at a constant speed until you tell it to stop.

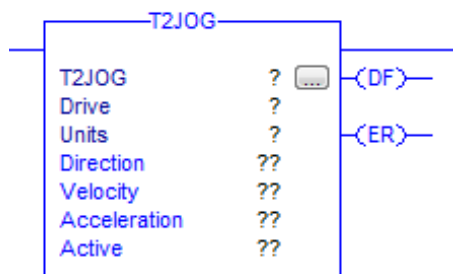

Exlar Tritex II EIP_AOI Manual

Required	Parameter	Type	Usage	Format	Description	Modbus Alias
X	Drive	Exlar_Drive	InOut	Tag	Point to	---
X	Units	Real[5]	InOut	Tag	Point to T2UU AOI	---
	Direction	INT	Input	Immediate or Tag	Direction Bit.0: Jog Plus Bit.1: Jog Minus	--- 4317.4 4317.5
	Velocity	INT	Input	Immediate or Tag	Jog Velocity (User Units)	6022
	Acceleration	INT	Input	Immediate or Tag	Jog Acceleration (User Units)	6026
	ER	BOOL	Output		An Instruction error is Active 1: T2UU error is active	---
	DF	BOOL	Output		A Drive Fault is active	104.03
	Active	INT	Output	Immediate or Tag	Status information Bit.0: Jog Plus active Bit.1: Jog Minus active Bit.2: The <i>STOPPED</i> flag is active while the <i>STOP</i> input event is active Bit.3: The <i>READY</i> flag is set when both the <i>ENA</i> and <i>HOMED</i> flags are active indicating that the drive is homed and enabled.	--- 111.4 111.5 105.2 104.2

5.7 MOVE (T2MOV)

Use the instruction to execute an drive move operation. The user can specify the position as well as the desired velocity, acc/decel for the primary and secondary move. The instruction moves an axis to either a specified absolute position or by a specified incremental distance specified in user units.

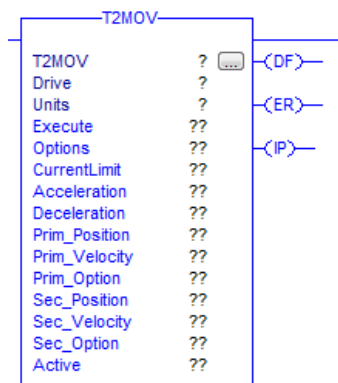

Exlar Tritex II EIP_AOI Manual

Required	Parameter	Type	Usage	Format	Description	Modbus Alias
X	Drive	Exlar_Drive	InOut	Tag	Point to	---
X	Units	Real[5]	InOut	Tag	Point to T2UU AOI	---
	Execute	INT	Input	Immediate or Tag	Move 0 Control	---
Bit.0: Move 0 Maintained					4318.0	
Bit.1: Move 0 Momentary					4319.0	
	Options	INT	Input	Immediate or Tag	Move 0 Options	---
Bit.0: Secondary Motion Enable					6100.0	
	Current Limit	REAL	Input	Immediate or Tag	Current Limit – Units is based on T2UU CurrentScale configuration	6101
	Acceleration	INT	Input	Immediate or Tag	Acceleration	6102
	Deceleration	INT	Input	Immediate or Tag	Deceleration	6500
	Prim Position	REAL	Input	Immediate or Tag	Primary Position	6108
	Prim Velocity	INT	Input	Immediate or Tag	Primary Velocity	6110
	Prim Option	INT	Input	Immediate or Tag	Primary Move Options	---
%000 = Absolute Position					6106.0	
%001 = Incremental					6106.1	
%010 = Unlimited (+)					6106.2	
%011 = Unlimited (-)						
%100 = Absolute (+) only					6106.4	
%101 = Absolute (-) only						
Bit.3: Limit maximum Current						
Bit.4: Terminate on Current Limit					6106.8	
Bit.5: Fault if terminated by current limit	6106.12					

Exlar Tritex II EIP_AOI Manual

Parameters (T2MOV) - continue

Required	Parameter	Type	Usage	Format	Description	Modbus Alias
	Sec Position	REAL	Input	Immediate or Tag	Secondary Position	6114
	Sec Velocity	INT	Input	Immediate or Tag	Secondary Velocity	6116
	Sec Option	INT	Input	Immediate or Tag	Secondary Option	---
%000 = Absolute Position					6112.0	
%001 = Incremental						
%010 = Unlimited (+)					6112.1	
%011 = Unlimited (-)					6112.2	
%100 = Absolute (+) only						
%101 = Absolute (-) only						
Bit.3: Limit maximum Current					6112.4	
Bit.4: Terminate on Current Limit					6112.8	
Bit.5: Fault if terminated by current limit	6112.12					
	ER	BOOL	Output		An Instruction error is Active 1: T2UU error is active	---
	DF	BOOL	Output		A Drive Fault is active	104.03
	IP	BOOL	Output		Move 0 In Position	108.0
	Active	INT	Output		Status information	---
Bit.0: Ready					104.2	
The <i>READY</i> flag is set when both the <i>ENA</i> and <i>HOMED</i> flags are active indicating that the drive is homed and enabled.						
Bit.1: Move 0 In Position					108.0	
Bit.2: Move 0 active	107.0					

5.8 HOST CONTROL (T2HC)

Use instruction to control drives Host Control Option.

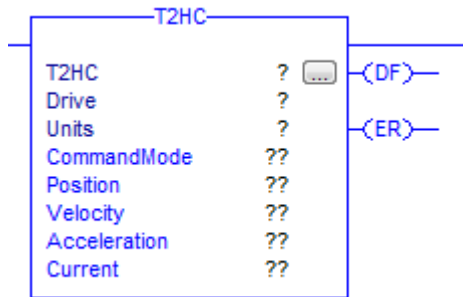

Required	Parameter	Type	Usage	Format	Description	Modbus Alias
X	Drive	Exlar_Drive	InOut	Tag	Point to	---
X	Units	REAL[5]	InOut	Tag	Point to T2UU AOI	---
	Command-Mode	INT	Input	Immediate or Tag	Direct Host Control 0 = Disabled 5 = Position 6 = Velocity 7 =Current	4303
	Position	REAL	Input	Immediate or Tag	Target Position	4304
	Velocity	INT	Input	Immediate or Tag	Velocity Limits	4306
	Acceleration	INT	Input	Immediate or Tag	Acceleration Limits	4308
	Current	REAL	Input	Immediate or Tag	Current Units is based on T2UU CurrentScale configuration	4310
	ER	BOOL	Input		A Instruction error is Active 1: T2UU error is active or Invalid CommandMode	---
	DF	BOOL	Input		A Drive Fault is active	104.03

6. USING THE AOI

This document outlines Exlar AOI User Instructions. These AOI are intended to be used with an Exlar Tritex II with EtherNet/IP adaptor. The AOI was created using Allen-Bradley Studio 5000 version 32 and is intended for use with Studio 5000 version 32 or greater.

The AOI will provide a simplified method for the user to perform operation and retrieve status of the drive. They work in conjunction with a set of Tritex II drive files which contain necessary translation tables. The following are functions the user could execute with the AOI.

- Drive Parameters (T2Drive)
Copy Parameters to/from IO
- User Units (T2UU)
Converts user units
- Control Drive (T2CON)
Instruction initiates command (Enable, Home etc) and Motion commands (Stop, Pause etc.)
- Drive Status (T2STA)
Instruction blends returns drive status (homed, enabled etc.) with positional information
- Jog operation (T2JOG)
Command Jog operation and associated parameters.
- Move operation (T2MOV)
Controls one complete move operation Primary and Secondary
- Host Control (T2HC)
Enable and run Host Control

6.1 IMPORTING AOI

The AOI was created using Studio 5000 version 32; there are no embedded AOI's within the AOI. The AOI is not protected; the Parameters, Local Tags and Logic may be edited by the user if desired. The user must assume responsibility for the operation and usability of the AOI when editing.

This section will give a general overview of adding and using Studio 5000, for detail information refer to Rockwell Automation literature.

Download and unzip the Exlar AOI zip file from the Exlar website at <http://www.exlar.com>. When AOI are imported Exlar Data Types are automatically imported.

Open Studio 5000 /Logix Designer and right-click on "Add-On Instructions" in the Controller Organizer tree then select "Import Add-On Instruction..."

From Studio 5000 /Logix Designer and right-click on "Import Component" in the File pull down tab then select "Add-On Instructions ...". ***Each AOI must be manually imported separately.***

Navigate to the unzipped file directory, select the AOI file and click the “Import...” button as shown in

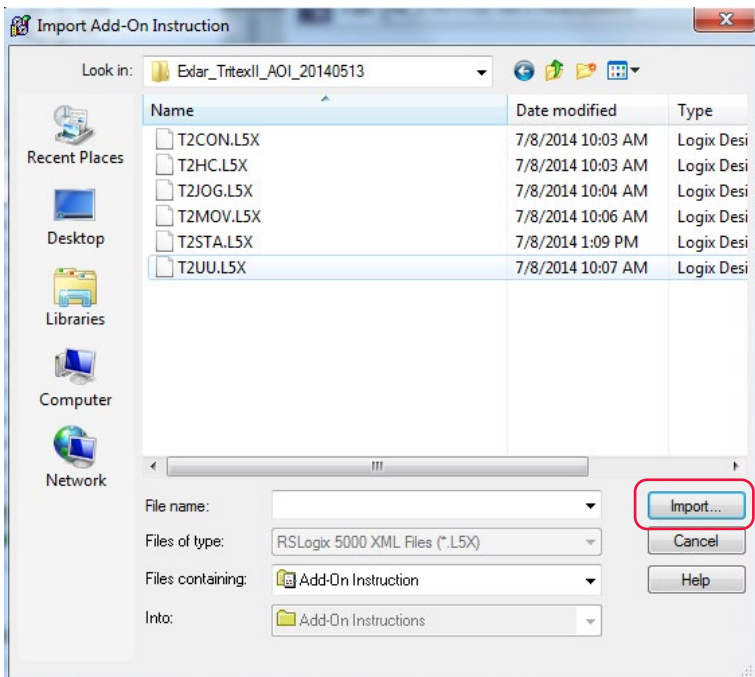

The “Import Configuration” window will display the AOI import properties and notify the user of any warnings or errors. Click “OK” in the “Import Configuration” window.

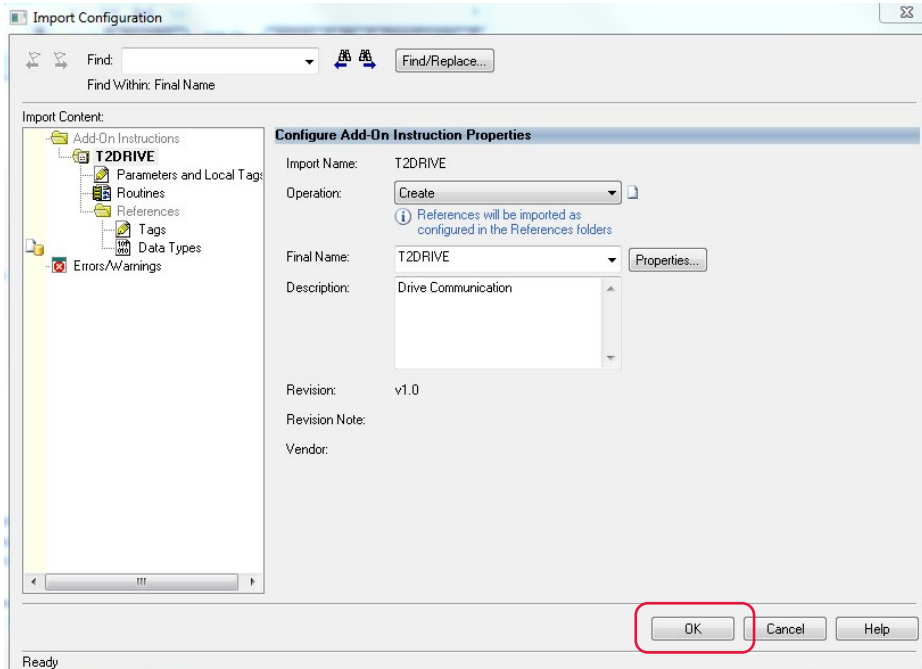

The imported AOI now appears under the “Add-On Instructions” folder of the Controller Organizer tree. Continue importing Add-On Instruction until Control Organizer tree match list below

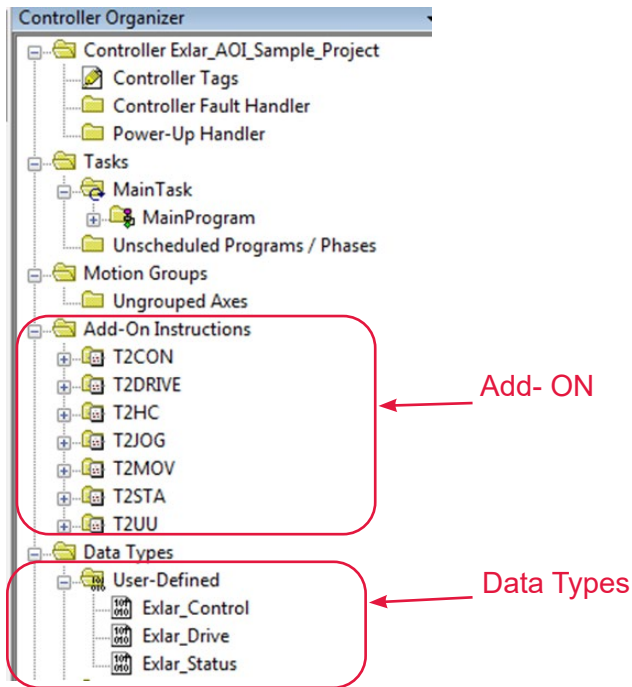

6.2 EXAMPLES

The following is an example using Host Control Mode with AOI's. Tag names are for sample reference only.

- Add New Module to Ethernet with Name TritexII

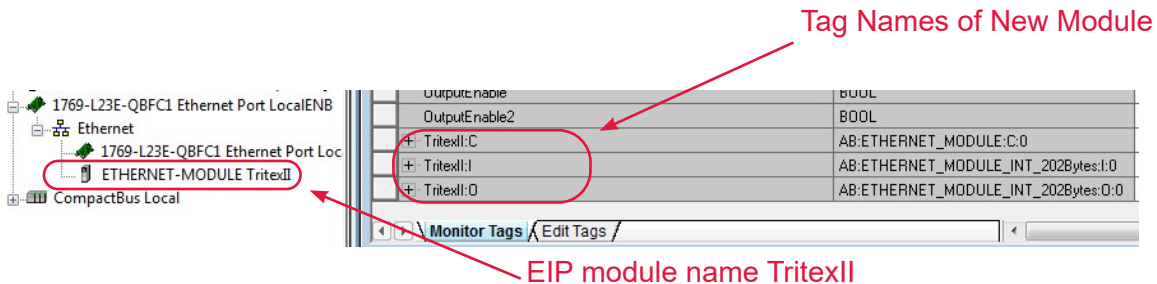

- Define Application Tags
 - TritexII_Drive: Data Type Exlar_Drive – common tag name for AOI's variables.
 - myUnits: Array of 5 real- used to define common units of measure for AOI's

6.2.1 Host Control

Host Control – Position Move

Target Position	5.000 IN
Velocity	25 IN/S
Acceleration	45 IN/S/S
Current (Limit)	5.0 AMPS

- Configure User Units (T2UU)

Example has no gearing and Units are Inches, refer to Expert Software scale factor for T2UU values.

	Units	Decimal Places	Display Text	Scale Factor
Distance:	Inches	0.000	IN	7.62939453125E-06
Velocity:	InchesPerSecond	0.0	IN/S	2.98023223876953E-08
Acceleration:	InchesPerSecondPerSecond	0	IN/S/S	4.76837158203125E-07

- Enter Example scaling units into T2UU AOI.

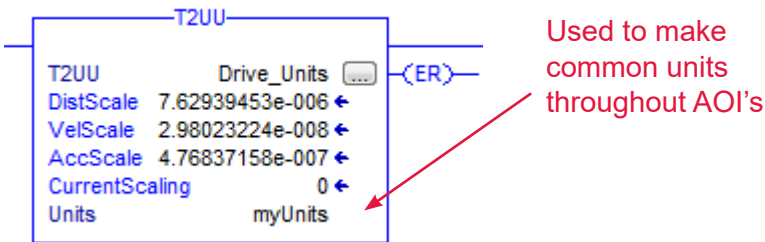

Exlar Tritex II EIP_AOI Manual

- Assemble Application using AOI functions.

Note how variables are connected between the AOIs and Module

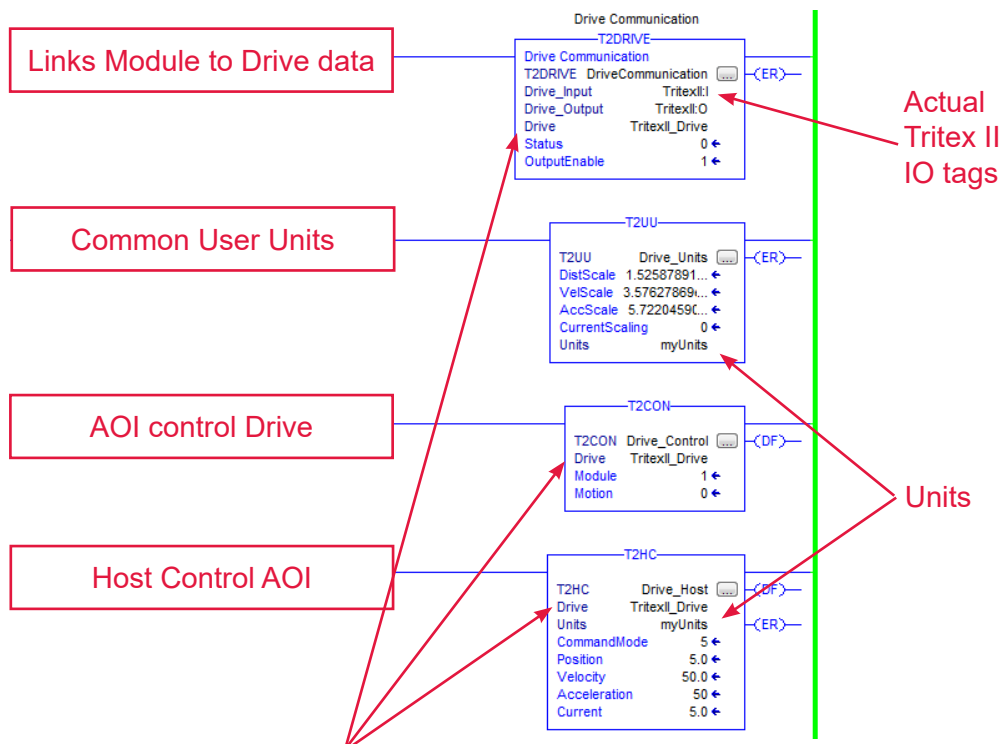

Tag TritexII_Drive is the common tag, allowing T2Drive to direct the data to where it will read and written to.

- Add Logic needed to control Position Host Move
 - Assume Actuator is Homed
 - (1) Enable Output Command by setting bit (T2DRIVE)
 - (2) Enable Host Position Control (T2HC)
 - (3) Write Host Position Parameters (T2HC)
 - (4) Enable Momentary (T2CON)
- Drive will Immediately move to Target Position

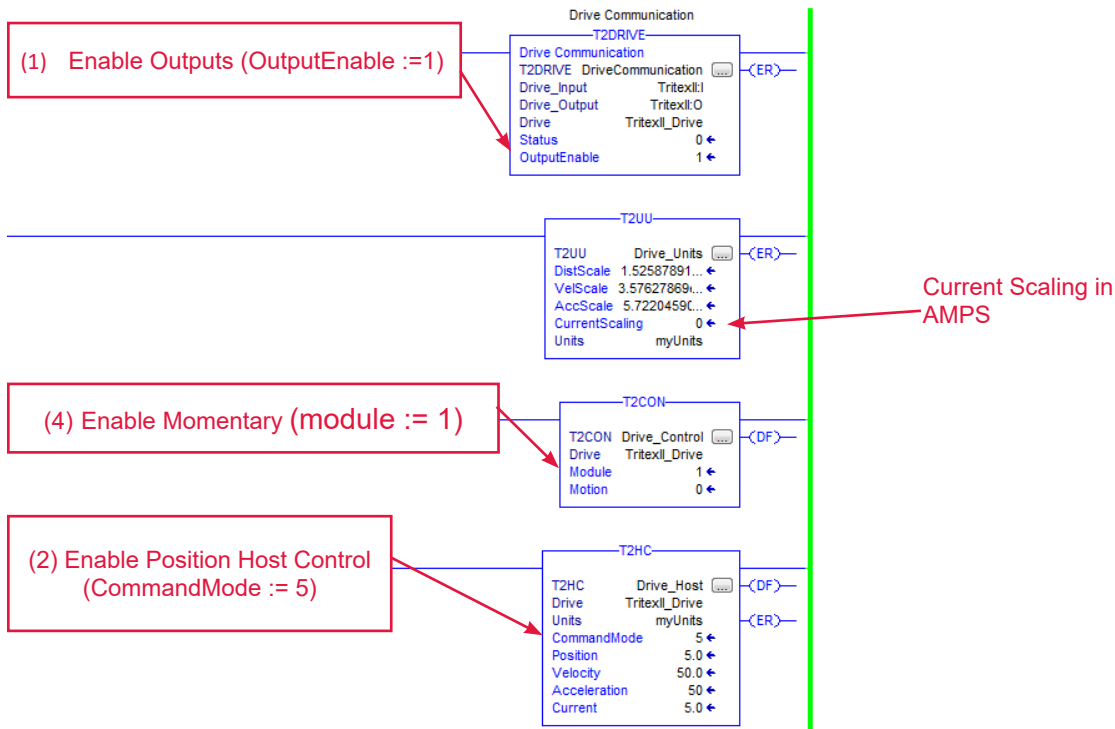

Note: From the Expert software actual commanded values can be display by selecting item and right-clicking and performing “read value from connected drive”

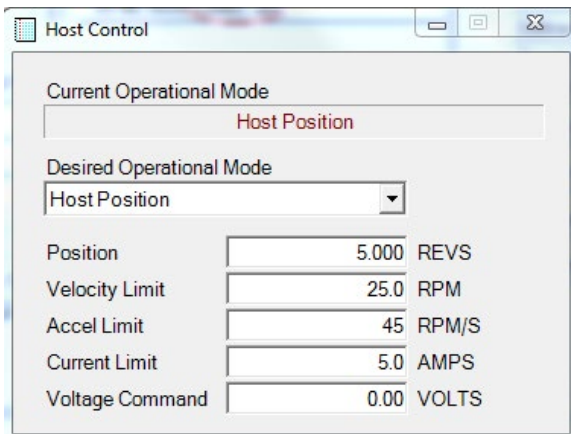

6.2.2 Jog

Jog (+)	
Velocity	10 IN/S
Acceleration	50 IN/S/S

- Enter Example scaling units into T2UU AOI.

	Units	Decimal Places	Display Text	Scale Factor
Distance:	Inches	0.000	IN	1.52587890625E-06
Velocity:	InchesPerSecond	0.0	IN/S	5.96046447753907E-09
Acceleration:	InchesPerSecondPerSecond	0	IN/S/S	9.53674316406251E-08

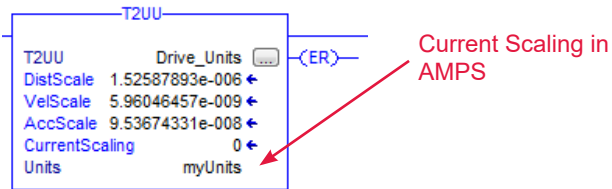

- Add Jog Logic
 - (1) Enable Output Command by setting bit (T2DRIVE)
 - (2) Write Jog parameters (T2JOG)
 - (3) Enable Momentary (T2CON)
 - (4) Enable Jog [+] (T2JOG)

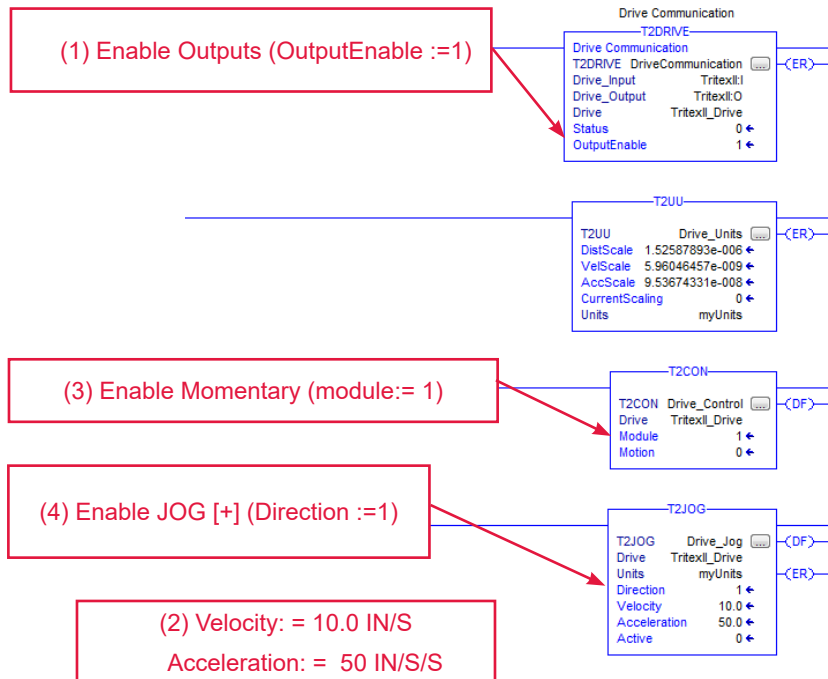

7. TROUBLESHOOTING

- Using BOOTP (Bootstrap Protocol) and cannot change IP address?
- Check if Tritex II BOOTP is enable or PC Ethernet connection are not correct. Read Rockwell BOOTP server manual for recommend firewall and virus software setting.
- Replacing Tritex II with another drive at the same IP and PLC does not recognize new Tritex
- Some PLC save the last active Tritex MAC ID. To force the PLC to recognize the replacement Tritex using the same IP address, try-power cycling the PLC's, forcing the PLC to map new MAC ID.
- Will not accept new IP address using Expert software
- BOOTP could be enable. Alternatively, the Factory Parameter could be incorrect. Verify the Factory configuration for EtherNet Option Board is enable and baud rate is at 230,400. See Expert Manual for factory configuration.
- Expert software displaying Correct distance or velocity but, PLC application does not
- The Tritex II has its own units, which the Expert software converts to display user units. The scale factor can be located on Expert software User Units Page or can be calculated using TritexII Parameter Manual scaling application note.
- How to determine if BOOTP Enable
- There is no direct method to determine BOOTP is enable. User can connect BOOTP server and monitor for BOOTP request. Another method is attempted to change IP address using Expert software. If successful, BOOTP is disabled.
- What happens if BOOTP is enable and BOOTP service times out
- The last valid BOOTP address will be use after 10 seconds. The default address is 192.168.0.254
- How to disable BOOTP
- Refer to Rockwell for more information.

8. GLOSSARY OF TERMS

AOI	Rockwell Add-On Instruction is intended to be used to encapsulate commonly used functions.
InOut parameter	An InOut parameter defines data that can be used as both input and output data during the execution of the instruction. Because InOut parameters are always passed by reference, their values can change from external sources during the execution of the Add-On Instruction
Modbus Alias	Represents the Tritex II Modbus Parameter ID. For example, in the AOI T2CON has a parameter 'Module' defines bit 2 as Define Home with an alias of '4316.10'. This implies this bit is mapped to Tritex II Modbus parameter ID '4316 bit 10'. If a alias is without decimal "4316" this imply the AOI parameter is mapped to the entire Modbus Parameter.
Client / Server	The convention in this section of the manual is from the PLC (Client) perspective. As such, an assembly called an "Output Assembly-Instance" when outputted from the PLC and received by the Tritex (Server). An "Input Assembly-Instance" outputted from the Tritex and read by the PLC.
Implicit Messages	The exchanged across I/O Connections with an associated Connection ID. The Connection ID defines the meaning of the data and establishes the regular/repeated transport rate and the transport class. No messaging protocol is contained within the message data as with Explicit Messaging. Implicit Messages can be point-to-point (unicast) or multicast and are used to transmit application specific I/O data
Explicit Messages	Messages sent as a connected or unconnected message. CIP defines an Explicit Messaging protocol that states the meaning of the message. This messaging protocol is contained in the message data. Explicit Messaging provide the means by which typical request/response oriented functions are perform. These messages are typically point-to-point. Message rates and latency requirements are typically not as demanding as I/O messaging
Unicast vs. Multicast	Unicast packets are-sent directly to a single device. Multicast packets are-sent to all devices on the network by default.

USA – EXLAR AUTOMATION

Curtiss-Wright

18400 West 77th Street
Chanhassen, MN 55317
Phone: 855-620-6200 (US & Canada)
Phone: 952-500-6200
Email: CHA_info@curtisswright.com
Website: www.exlar.com

ASIA – EXLAR ASIA PACIFIC

Curtiss-Wright

1007 Pine City Hotel
8 Dong An Road, Xuhui District
Shanghai 200032 China
Phone: +86 021-6495-7868
Email: mfan@curtisswright.cn
Website: www.exlar.com/zh-hans/